



OXYGENATING WATER TECHNOLOGY

ACQUAECOREMEDY

COMPANY

Acquaecoremedy offers systems and equipments for the water treatment, using own patented technology that provides high efficiency purification results at the lower energy consumption, which has always been the milestone of our mission. Submersible electro-injectors suitable to improve all existing treatment processes and for the future more efficient ones.

Acquaecoremedy designs and realizes treatment plants with all the classical technologies, including the traditional ones, which are mainly suitable for civil or equivalent discharges, as well as the more modern and efficient ones suitable for industrial discharges with particular purification needs, ensuring the partial or total water reuse into the food industry processes, always with attention for the specific request and process.



CIVIL AND INDUSTRIAL
WASTEWATER TREATMENT



ENVIRONMENTAL
RESTORATION



PROCESSING IN
PRODUCTION SYSTEMS





TECHNOLOGY COMPARISON



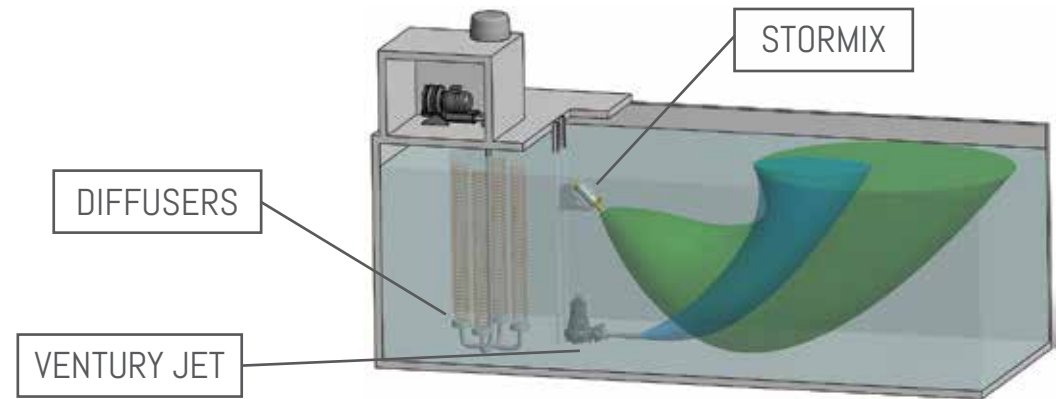





There are several oxygenation solution in the water treatment plants, but the most commonly used are blowers with diffusers or venturi-jet, depending on the size and kind of treatment.

In the table below, we compare these traditional technologies with the innovative Stormix submersible aerators that offer both process and maintenance benefits as well as initial investment.



	STORMIX	BLOWERS + DIFFUSERS	VENTURI JET
DISSOLUTION EFFICIENCY	<p>UP TO 50%</p> <ul style="list-style-type: none"> • Performance is more closely linked to the water column and the resulting bubble retention time, rather than to installed power. • Technical gases like ozone and oxygen can be injected in its standard configuration as well. This feature makes it the perfect solution whenever a strong chemical oxidation is required. 	<p>UP TO 7%</p> <ul style="list-style-type: none"> • Its performance can be increased using add-on components (circulators) • They can only inject air. • As the water column increases, the power required for operation will increase accordingly. 	<p>UP TO 25/30%</p> <p>The installed power is directly linked to the depth of the tank and to the resulting pressure that the pump has to overcome. It can only inject air.</p>
BUBBLE SIZE	<p>The high rotation speed of the propeller generates a large amount of MICRO-BUBBLES having a diameter less than 1 mm. As a result, a very large air-water exchange surface is created.</p> 	<p>Medium or large-diameter bubbles can be generated depending on the type of diffuser. Smaller bubbles can be generated provided that the blower's power is significantly increased. The plates with micro-holes can get easily clogged.</p> 	<p>Medium-large diameter bubbles. Since air comes into contact with water inside an ejection tube, the bubble diameter is only reduced by the turbulence of the flow.</p> 
MIXING	<p>Great capacity of mixing and homogenization. Bubbles follow the flow generated by the impeller and afterwards rise vertically to the surface. The spreading of the bubbles all over a large surface prevents them from aggregating, that would lead to a lower dissolution efficiency. Its circulation capacity makes the entire volume's treatment easier, avoiding the settling of solids and the appearance of dead zones with a low oxygen concentration.</p>	<p>Low mixing and homogenization capacity. Bubbles rise to surface following a vertical trajectory, causing a shorter contact time with water. While rising, bubbles aggregate, increasing their average diameter and reducing the air-water contact surface. As a result, the dissolution efficiency drops.</p>	<p>Low mixing capacity. Starting from the bottom, bubbles rise to the surface with a strongly vertical trajectory. The mixing effect is very moderate and it is generated by the water flow of the pump, which is determined by its specific flow rate.</p>
AIR TEMPERATURE	<p>It injects air taken directly from outside without changing its temperature.</p>	<p>The blower and the air distribution tubes heat up during operation, increasing the temperature of the injected air. Consequently, injected air will contain a lower percentage of oxygen.</p>	<p>It injects air taken directly from outside without changing its temperature.</p>



<p>INSTALLATION</p>	<p>Low installation costs. Easy system with self-standing components. No additional spaces are required. It can be installed on floating supports for test purposes without stopping the system.</p> 	<p>High installation costs. Complex system: valves, downpipes, pipes, diffusers. A dedicated, soundproof and air-conditioned technical room is needed for the blower.</p> 	<p>Low installation costs. Easy system with self-standing components. No additional spaces are required. It cannot be installed for test purposes, because it needs to be installed on the bottom and motors are usually heavy and cumbersome.</p> 
<p>MAINTENANCE</p>	<p>Self-standing components. It does not require the system to be emptied or stopped and it can be handled from the surface or through inspection. Easy and quick handling that can be carried out by just one operator. All motors can be fully reconditioned through agreed maintenance programmes.</p> 	<p>Single system. The water treatment system has to be stopped and the compartment needs to be emptied and sanitised before having access to diffusers. Complex maintenance due to the high number of elements to be installed, which are also difficult to be reached for checking purposes.</p> 	<p>Self-standing components. It does not require the system to be emptied or stopped and it can be handled from the surface or through inspection. Easy and quick handling that can be carried out by just one operator only for the smallest models.</p>
<p>NOISE AND HEATING</p>	<p>The submersible motor does not heat up and it is very smooth-running.</p> 	<p>The external blower generates noise and can reach high temperatures.</p> 	<p>The submersible motor does not heat up and it is very smooth-running.</p> 
<p>ENERGY CONSUMPTION / EFFICIENCY</p>	<p>Higher energy efficiency. Since the aerator is installed a few centimetres away from the surface, the pressure that needs to be overcome to inject air is really low. The bubbles trajectory is the longest possible. Starting from the surface, they reach the bottom and spread all over a large area, then they slowly rise towards the atmosphere.</p>	<p>The deeper the tank, more power will be needed to allow the blower to suck in air from the surface. Injection is performed on the bottom and without using mixers. This causes a quick rise of the bubbles towards the surface.</p>	<p>The deeper the tank, more power will be needed to allow the pump to suck in air from the surface. Injection is performed on the bottom and without using mixers. This causes a quick rise of the bubbles towards the surface.</p>

STORMIX PR

Stormix PR is our most powerful electric, submersible, and ultra-high efficiency aerator, available in bronze or cast iron. Aside from circulating the water, Stormix PR is capable of breaking down the air bubbles to such a size as to ensure oxygen transfer rates that are vastly superior to traditional aeration systems.

All the different kinds of support for Stormix PR is vertically adjustable up to 45° degrees to better adapt to all possible forms of bodies of water to be oxygenated. Stormix PR aerator can be installed in two main versions: with floats to track tank water levels in aerated equalization tank, or on fixed supports anchored to the bottom, the walls or pillars present in the pool or lake.



50 HZ

Three phase 230 V - 400 V	Propeller	Nom. Pow. HP	Nom. Pow. kW	Abs. kW	r.p.m. / 1"	Weight kg
PR 30 T	A-C	3.0	2.2	2.9	2800	26
PR 40 T	A-C	4.0	3.0	4.1	2800	28

Other voltage available on request

60 HZ

Three phase 230 V - 380 V - 400 V	Propeller	Nom. Pow. HP	Nom. Pow. kW	Abs. kW	r.p.m. / 1"	Weight kg
PR 30 T	A-C	3.0	2.2	2.9	3350	26
PR 40 T	A-C	4.0	3.0	4.1	3350	28

Other voltage available on request

ACQUAECOREMEDY

Oxygenating Water Technology



UP TO
40-50%
WITH AIR

UP TO
95%
WITH PURE
OXYGEN



01 | AERATION

+



02 | CIRCULATION

+



03 | WIDESPREAD

=

BEST
EFFICIENCY
IN OXYGEN
TRANSFER
RATE

A world map is centered on the image, rendered in white against a teal background. The background features a faint, artistic depiction of a forest with tall, thin trees and a stream. The map has several green location pins placed across it: one in North America, a cluster of about eight in Europe, one in Africa, one in Asia, one in Australia, and one in South America. The text 'WHERE WE OPERATE' is written in a large, white, sans-serif font across the middle of the map. At the bottom center, there is a horizontal bar consisting of a white segment on the left and a green segment on the right.

WHERE WE OPERATE

ACQUAECOREMEDY IS
THE ENVIRONMENTAL DIVISION OF



VIA AUGERA 5/A
42023 CADELBOSCO SOPRA
REGGIO EMILIA - ITALY

TEL. +39 0522 918769
FAX +39 0522 918790
INFO@ACQUAECOREMEDY.COM

WWW.ACQUAECOREMEDY.COM